



SPECTRA

HDMI Wireless Video Transmission

EU Environmental Protection

Waste electrical products should not be disposed of with household waste. Please recycle where facilities exist. Check with your local authority or retailer for recycling advice.



SHENZHEN CRYSTAL VIDEO TECHNOLOGY CO.,LTD

ADD: Unit 05-06, Floor 24, Changhong Science & Technology Mansion, Keji 12th Road South, High-tech Industrial Park, Nanshan District, Shenzhen, P.R, China

Post code: 518057

www.cv-hd.com

Tel: +86-755-29977913

E-mail: Sales@cv-hd.com

Facebook: [@crystalvideowireless](https://www.facebook.com/crystalvideowireless) Instagram: [cvwtechnology](https://www.instagram.com/cvwtechnology)

USER MANUAL

This user manual applies to:

Transmitter: 7157

Receiver: 3157





Version: 1.0

Important Information

Please read this user manual carefully before using this product. In accordance with the safety precautions and operating instructions listed on this user manual, please use the product in a correct way. It does not apply in cases as follows:

- Repair or product modification have been executed by unqualified personnel.
- The damage is caused by accidents including but not limited to lightning, fire, exposed to rain or water, and moisture.
- Don't use provided CVW power adapter.
- The model label on the product has been modified or removed by unqualified personnel.

Safety Precaution

 Danger High voltage	To avoid electric shock, do not remove or open the cover. No user-serviceable parts are inside, please contact original factory for maintenance.
 Beware of hot surfaces	The high temperature in the process of operating the device may cause the high risk of scalding.
 Caution!	Please use our standard power adapter. As for the detailed information, please refer to the rated voltage shown on the CVW power adapter.
 Fragile	Handle with care!

Danger: Be careful with electricity

- When connecting to any devices, please turn off the product before any operation.
- Power outlet: To avoid electric shock or fire, short circuit, please make sure that the input voltage of adapter is AC110V-220V.
- Lightning: Unplug the product if it has not been used for a time or in lightning weather.

Warning

- This product should not be exposed to dripping or splashing. Please keep any liquid thing off the product.
- To avoid electric shock, please do not stick anything on the air vent of product; do not remove the cover or put the object like pins, steel wire into the gap of the air vent.
- Ventilation: Please do not block the air vents on the receiver/transmitter or place any object on top of them.
- Water Exposure: To avoid electric shock or fire, please do not expose the receiver/transmitter to rain or moisture.
- We assume no responsibility for any damage or result caused by not using original adapters.

Special Notice

- This product operates at 5GHz band, when it's in the complex environment, its transmission capability may be affected by metals, walls, or crowd etc.
- This product has been tested and manufactured to comply with international electrical safety regulations, however, there may be noise caused by the interference with other equipment in rare cases. If the interference is happened, please keep a certain distance away from other equipment.
- The product is susceptible to interference from 5GHz internet (LAN) or other wireless devices.
- Please do not deploy the transmitter and receiver on metal cages or shelves, or it may affect the wireless communication.
- The product is equipped with data transmission encryption functionality, but it still should be pay attention to remain vigilant against deliberate signal interception. Please refrain from utilizing it for confidential or crucial communications.
- The system requires approximately 30 seconds to initialize, during which the media receiving end will be inactive.
- Please note that different software versions and functionalities are not interchangeable or replaceable.

CONTENTS

Cautions	01
About the User Manual	02
Product Overview	02
Product Highlights	02
Packing List	03
Ports and Buttons	04
Button Function Description	06
LCD Display	10
Product Installation	12
System Connectivity Diagram	15
Product Specifications	16
Troubleshooting	17

Cautions

Thank you for choosing CVW professional wireless video transmission system. Before using this product, please read carefully the following cautions:

- * Avoid prolonged exposure to the direct sunlight or use this product in dusty environments.
- * Be sure to use the product within the temperature and humidity range.
- * Do not expose this product to violent vibration, or strong magnetic fields.
- * Do not contact conductive materials with the interior of the product.
- * Do not disassemble the product enclosure without the guidance.
- * Be sure to use the proprietary power adapter to power up the device.
- * Make sure the antennas has been installed before powering up.
- * This product is a 5GHz Wi-Fi device. Try to change a channel if this product is interfered by other 5GHz devices.
- * The operating band of this product is 5GHz band, when it's in a complex environment, its transmission distance may be affected by metals, walls, or crowd etc. Please ensure that the antennas at the transmitter and the receiver are visible.

Special Precautions:

- * When installing the articulating arm on the device, please do not hold the device by hand to rotate and fasten it.

About the User Manual

This manual includes the product's specifications and a detailed introduction to its troubleshooting. Before using this product, please carefully read this manual. If you have any question or concern while using this product, please contact us or our dealers as soon as possible.

Product Overview

SPECTRA is a set of wireless high-definition video transmission system supporting three power supply options: DC, Type-C, and NP-F batteries. It boasts a maximum video resolution of 1080P/60Hz and operates on 5.8GHz wireless network technology for transmission. Leveraging H.265 encoding/decoding technology, it supports the setting that transmits the video signal from one transmitter to two receivers.

Product Highlights

- **Three types of image qualities for choosing: Long distance mode, normal quality mode or high quality mode.**

- **HDMI Loop-Out**

The product supports HDMI input while also offering HDMI zero-delay loop-out. It can be connected to a monitor or another wireless video transmitter. No need to worry about insufficient HDMI ports.

- **One Transmitter-to-Two Receivers Broadcasting Setting**

The product supports simultaneous reception of one video signal by two receivers. The image can achieve a maximum resolution of 1080P/60Hz. Both video signals share a wireless channel, significantly saving spectrum resources. It provides great convenience for multi-user monitoring, and both receivers support UVC video capture simultaneously.

- **UVC Video Capture**

Alongside HDMI output, the product supports UVC video capture. By connecting to a PC via USB data cable, the video resource can be captured, enabling the user do live stream.

Below is the UVC video capture software download link.

<https://obsproject.com/zh-cn/download>

- **Recording and Playback**

The product supports one-key video recording and playback, allowing users to review the recorded content for evaluation. The TF card design enables easy insertion and facilitates users in post-production editing.

- **Channel Scan**

The product supports channel scanning, allowing users to assess the signal interference situation in the current area. Red indicates high interference, while white indicates usable channels. This resolves video transmission instability caused by interference, significantly enhancing the user experience.

Packing List

Please check the following items carefully after unpacking. If any of them is missing, please contact your seller.



Transmitter x1



Receiver x1



Warranty x1

Ports and Buttons

TX:7157

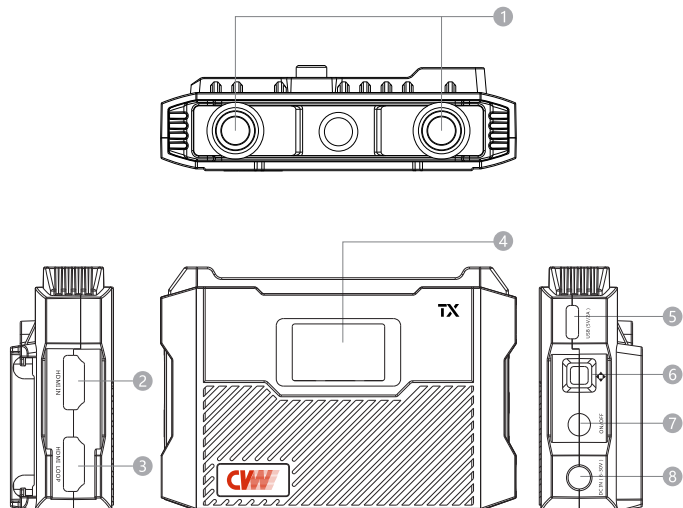

- ① Antenna Connectors
- ② HDMI IN
- ③ HDMI Loopout
- ④ LCD Display
- ⑤ TYPE-C Power Port
- ⑥ Main Menu
- ⑦ Power Button
- ⑧ DC Power Port

RX:3157

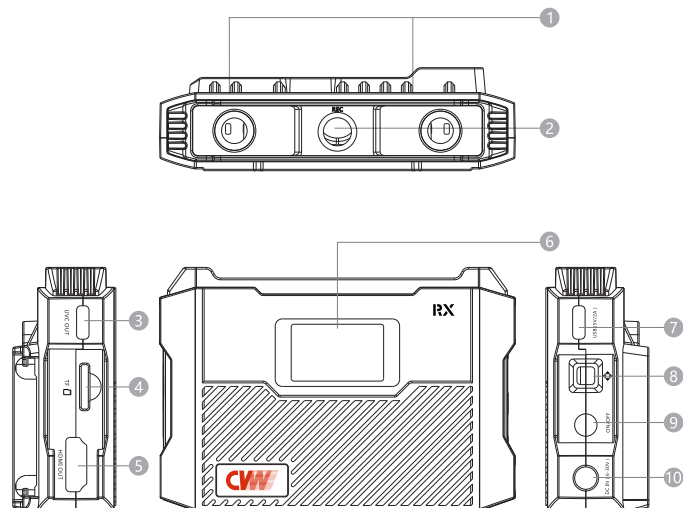

- ① Antenna Connectors
- ② Record
- ③ UVC OUT
- ④ TF Card
- ⑤ HDMI OUT
- ⑥ LCD Display
- ⑦ TYPE-C Power Port
- ⑧ Main Menu
- ⑨ Power Button
- ⑩ DC Power Port

Buttons Function Description

TX:7157

Function	Operation	Instruction
Power Button	Long press for 3 seconds	The illuminated display indicates successful startup, while a dark display indicates shutdown.
Channel Switch	Toggle the function button	Toggle the function button in upward, downward, left, and right directions to switch channels, and press it to confirm the operation.
Menu	Long press the function button	Long-pressing the function button enters the menu, which includes system settings, channel scanning, recording and playback, mode selection, and return options.
Pairing	Long press to enter the menu options, select the settings option, short press to enter the pairing selection, and short press again to confirm.	The transmitter and receiver need to be paired simultaneously to establish a connection. After activating the pairing function, wait for a few seconds, the pairing will be successful.
Mode Selection	After entering the menu by long press the function button, select the mode option, and short press it to confirm.	After entering the mode selection, user can choose between long-distance mode, normal quality mode or high quality mode.

Function	Operation	Instruction
Language	Toggle the function button	After entering the menu by long press the function button, select the language option, and short press it to confirm. After entering the language menu, the user can choose Chinese or English.
Update	Toggle the function button	After entering the menu by long press the function button, select the updating option, and short press it to confirm. After activate the updating option, the user can choose YES or NO. If you choose YES, please plug the USB drive what have been downloaded the updating files into our device. The system will be recognized and updating automatically, after that it will be restarted automatically.

RX:3157

Function	Operation	Instruction
Power Button	Long press for 3 seconds	The illuminated display indicates successful startup, while a dark display indicates shutdown.
Channel Switch	Toggle the function button	Toggle the function button in upward, downward, left, and right directions to switch channels, and press it to confirm the operation.
REC	Short press REC button	After inserting the TF card, press the record button to start video recording.
Menu	Long press the function button	Long press the function button to enter the menu, which includes system settings, channel scanning, recording and playback, mode selection, and return options.
Pairing	Long press to enter the menu options, select the settings option, short press to enter the pairing selection, and short press again to confirm.	The transmitter and receiver need to be paired simultaneously to establish a connection. After activating the pairing function, wait for a few seconds, the pairing will be successful.
Channel Scan	After entering the menu by long press the function button, select the channel scan option, and short press it to confirm.	After activating the channel scanning function, wait for a few seconds to see the interference status of each channel on the display. The user can choose the channel with the least interference based on the displayed channel quality.
Playback	After entering the menu by long press the function button, select the play option, and short press it to confirm.	After entering the playback file directory, the user can choose the file that wants to playback and press the function button shortly to start playback.

Function	Operation	Instruction
Language	Toggle the function button	After entering the menu by long press the function button, select the language option, and short press it to confirm. After entering the language menu, the user can choose Chinese or English.
Update	Toggle the function button	After entering the menu by long press the function button, select the updating option, and short press it to confirm. After activate the updating option, the user can choose YES or NO. If you choose YES, please plug the USB drive what have been downloaded the updating files into our device. The system will be recognized and updating automatically, after that it will be restarted automatically.

LCD Display

TX:7157

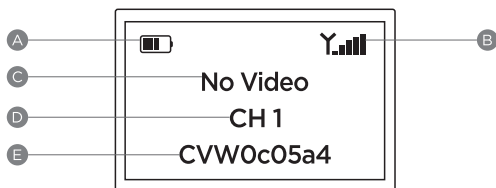

Item	Icon	Content	Status
A	Power Supply Information		<p>When the system is connected to the battery connector (DC 7.4-16.8V), the battery level displays with 5 bars, each representing 20%. If the battery level drops below 1 bar, the battery icon turns red and flickers.</p> <p>Power supplied through the DC power input (6-30V) or USB (5V/2A). It will be indicated by the appearance of "DC" on the display.</p>
B	Signal Strength		The signal strength is represented by a bar with 5 levels. Full bars (≥4) are shown in green, 2-3 bars in yellow, 1 bar in red, and an "X" indicates no network connection.
C	Video Status	No Video	No video signal is detected
		1080P60	Video signal is detected
D	Channel Status	CH1	The current channel is displayed, e.g., "CH 1."
E	SSID	CVW*****	Displays the device's WIFI name, such as CVW*****.

RX:3157

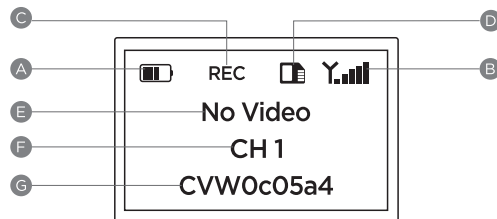

Item	Icon	Content	Status
A	Power Supply Information		<p>When the system is connected to the battery connector (DC 7.4-16.8V), the battery level displays with 5 bars, each representing 20%. If the battery level drops below 1 bar, the battery icon turns red and flickers.</p> <p>Power supplied through the DC power input (6-30V) or USB (5V/2A). It will be indicated by the appearance of "DC" on the display.</p>
B	Signal Strength		The signal strength is represented by a bar with 5 levels. Full bars (≥4) are shown in green, 2-3 bars in yellow, 1 bar in red, and an "X" indicates no network connection.
C	Recording Status	REC	<p>Red indicator light is flicker.</p> <p>Red indicator light is off.</p>
D	TF Card Status		The icon is light: The TF card is detected.
			Light off: No TF card is detected.
E	Video Status	No Video	No video signal is detected
		1080P60	Video signal is detected
F	Channel Status	CH1	The current channel is displayed, e.g., "CH 1."
G	SSID	CVW*****	Displays the device's WIFI name, such as CVW*****.

Product Installation

1. Install the antennas to the antenna connectors.(As shown in the figure below)

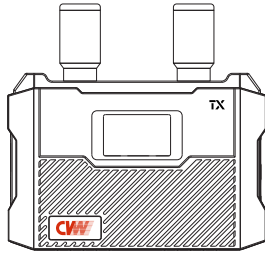

2. Please use the NPF battery, DC power or TYPE-C power supply to power up the transmitter and receiver.(As shown in the figure below)

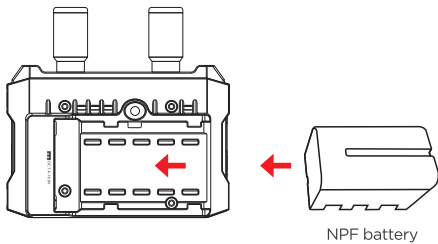

DC Power/ TYPE-C Power Supply

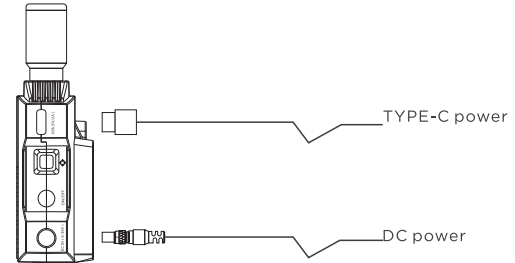

3. The receiver can be installed through the 1/4 screw hole in the bottom.
(As shown in the figure below)

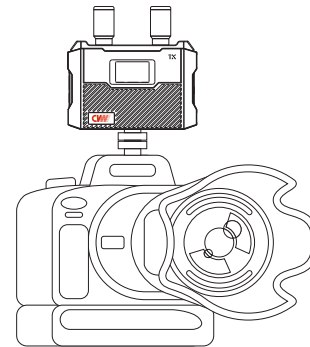

4. Please connect the transmitter to the camera with a HDMI cable.

(As shown in the figure below)

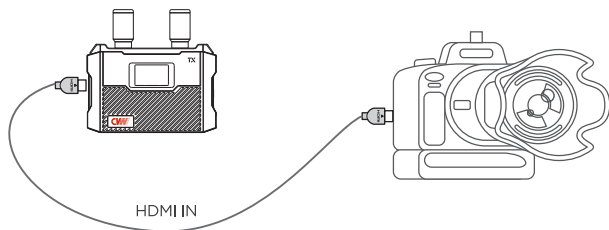

5. Please connect the receiver to a monitor or another receiving product with a HDMI cable.(As shown in the figure below)

(As shown in the figure below)

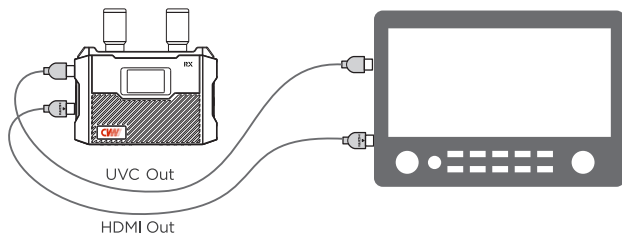

System Connectivity Diagram

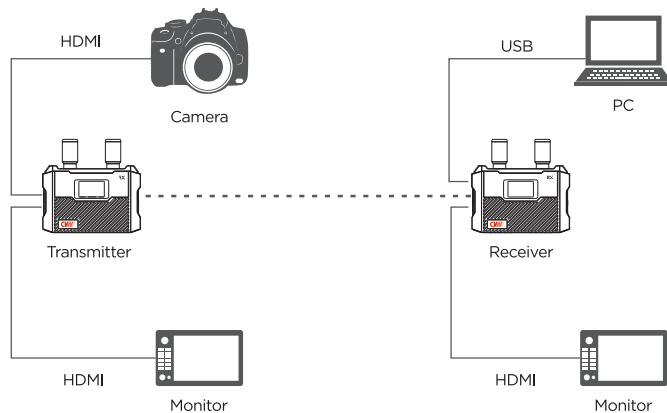

Product Specifications

ITEM	TX: 7157		RX: 3157	
Frequency	5.1-5.9GHz			
Video Resolution	1080p60/59.94, 1080p50, 1080p30/29.97, 1080p25, 1080p24/23.98 720p60/59.94, 720p50 480p, 576p 1024x768, 1280x768, 1366x768, 1920x1080, 1280x720 (Computer monitor resolution)			
Audio Format	PCM			
HDMI Protocol	HDMI 1.4			
Transmission Latency	80ms			
Video Codec	H.265			
Transmission Distance	350 meters			
Antenna mode	2T2R external antenna 2dBi			
Ports	HDMI input, HDMI loopout DC-IN, TYPE-C, NP-F battery		HDMI output, UVC output (TYPE-C) DC-IN, TYPE-C USB, TF card slot, NP-F battery	
LCD Display	Channel, Battery Power, SSID, Video Resolution, Signal Strength			
Working Voltage	DC 6-30V			
Product Size	100x65x22mm			
Power Consumption	TX: 3.5W, RX: 2.5W			
Temperature	-10-45°C (Working), -40-60°C (storage)			

Troubleshooting

1. Do not unplug HDMI cables from the transmitter and receiver during shooting.
- 2) Please connect the transmitter to the video source, and the receiver to the monitor, then power them up.
- 3) If the connection fails, please restart the transmitter and receiver. If the connection still fails, please refer to the button operation instructions to do re-pairing.
- 4) If the OSD shows that the pairing is failed, please restart the transmitter and the receiver. If the connection still fails after restarting, please do-pairing again.
- 5) If no video source is displayed on the monitor after switching the video source resolution, please re-plug the HDMI cable of the transmitter or receiver. If there is still no signal after unplugging and plugging the HDMI cable, please restart the transmitter and receiver.
- 6) If the connection cannot be established after switching the channel, please restart the transmitter and receiver.
- 7) If the image is interfered, please try to switch the channel or check the channel quality by using the receiver to select the usable channel.
- 8) Never power up the product without the original antennas and power adapter.
- 9) During use, the surrounding environment might affect wireless transmission quality. These situations are below:

a: Walls, large metal plates, and appliances may effect wireless transmission.

b: When using the equipment in crowded environment, please place the transmitter and receiver at the height of around 1.5-2 meters above the ground.

c: If 5GHz wireless devices are used nearby, these may also increase interference, which can be solved by switching to a different channel.

d: To achieve best wireless transmission performance, please keep a clear line of sight between the transmitter and receiver's antennas.