



EU Environmental Protection

Waste electrical products should not be disposed of with household waste. Please recycle where facilities exist. Check with your local authority or retailer for recycling advice.



Swift800 Pro

SDI & HDMI Wireless Video



SHENZHEN CRYSTAL VIDEO TECHNOLOGY CO.,LTD

ADD: Unit 05-06, Floor 24, Changhong Science & Technology Mansion, Keji 12th Road South, High-tech Industrial Park, Nanshan District, Shenzhen, P.R. China

Post code: 518057

www.cv-hd.com

Tel: +86-755-29977913

E-mail: Sales@cv-hd.com

Facebook: [@crystalvideowireless](https://www.facebook.com/crystalvideowireless) Instagram: [cvtechnology](https://www.instagram.com/cvtechnology)

USER MANUAL

This user manual applies to:
Transmitter: 7103
Receiver: 3103

Version: 1.0
2020.05.26

Important Information

Please read this user manual before you use this product, it contains all the notes and important things regarding operating this product. In accordance with the safety precautions and operating instructions listed on this user manual, our applies provided the product is handled properly for its intended use, but may not apply to below cases:

- Repairs or product modification and alterations have been executed by unauthorized personnel.
- The damages are caused by accidents including but not limited to lightning, fire, exposed to rain or water, and moisture.
- Do not use provided power adapter with specific power voltage which are not compliant with the rated voltage range in the attached label of the power adapter in package.
- The model label on the product has been modified or the warranty tag has been removed by unauthorized personnel.



Safety Precaution

	To reduce the risks of electricity, do not remove or open the cover. No user-serviceable parts are inside. Please return to original factory for maintenance
	The high temperature in the process of operating the device may cause the high risk of scalding.
	Please use our standard power adapter. Detailed information Please refer to the rated voltage range showed on the label at the back of package's power adapter.



Danger: Be careful with electricity.

- As connecting any equipment (such as any player or TV , etc.), please turn off the power to the product before any operation is undertaken.
- Power outlet: To prevent electric shock or fire, short circuit, please make sure the type of electrical plug used on the receiver's and transmitter's power cord are compliant with the rated voltage range in the attached label of the power adapter in package.
- Power cord: Do not place any heavy articles above on the power cord. To avoid being stepped on or pinched by heavy items, the power cord should not be located on the place where people pass by frequently.
- Power overloading: Avoid overloading wall's electrical outlets and extension cord or other multi-socket; otherwise could result in electric shock or fire.
- Lightning: For protection from lightning or when the product is left unattended for a long period, please disconnect it from the power source.
- Please disconnect the power cord from the power outlet when you are not using the receiver and transmitter, this will reduce the risk of electric shock or fire.



Warning

- This product should not be exposed to dripping or splashing. Do not place any object filled with liquid on the product(eg. vases).
- To avoid electric shock, please do not block or stick anything on the air vent of product; do not remove the cover or put the object just like pins, steel wire into the gap of the air vent.
- Please place the receiver/ transmitter on a flat with hard and stable surface.
- Ventilation: please do not block the air vents on the receiver/transmitter or place any heavy object on top of them . Blocking the air flow can damage the product itself. Please make sure that there is adequate ventilation distance between the receiver and TV, and also put the product away from direct sunlight or any source of heat.
- Water Exposure: To reduce the risk of electric shock or fire , please do not expose the receiver/transmitter to rain or moisture.
- We assume no responsibility for any damage or result caused by using other adapters instead of our standard adapters

Special Notice

- Although the product has provided the function of data encryption when transmitting, you still need to pay attention to deliberate signal interception. There will be the Possibility of a third party intentionally intercept the transmission signal since the product adopt wireless communication. Please do not use the product on confidential and important communications, or life-related communications The main concern is that the content of wireless communication might be received by the third party's wireless devices deliberately or accidentally.
- The impact of radio waves (such as the following environment may cause the abnormal audio and video(blocked image, noise ...etc.).
 - 1) Transmit near the wall which is hard for the radio waves to get through.
 - 2) Quite close to the refrigerator, metal fitment and appliances, or next to the crowded situation.
- This product has been tested and manufactured to comply with national electrical safety rules, however, there will be noise caused by the interference with other machines in rare cases. If the interference is happened, please keep a certain distance away from other machines.
- The product is susceptible to interference from 5GHz wireless local area network or other wireless devices.
- Optimal range between transmitter and receiver is between 1 meter and 30 meters with in line of sight indoor
- Please do not set up the transmitter and receiver in metal shelf, or it will hinder the wireless communications.
- It will take 30~40 seconds to boot the system before wireless communication start, the media receiver can not be operated during this time.

CONTENTS



CONTENTS

User Operation Instructions	01
About This Manual	01
Product Introduction	01
Connectivity diagram	02
Packing List	04
Product Interface Introduction	05
Transmitter Interface Introduction	05
Receiver Interface Introduction	07
Product Installation Operation Instructions	09
Powering on and booting up	12
OLED Screen	13
Button Function Instructions	15
How to Use the App	17
Product Specifications	18
Reminders	19
Troubleshooting	21

User Operation Instructions

Thank you for choosing CVW's professional wireless high-definition video and audio transmission product. Before using this product, please carefully read the following reminders:

- * Avoid exposing this product to direct sunlight or dusty places for a long period of time
- * This product must be used within its temperature and humidity range
- * Do not operate this product when it is vibrating or in a strong magnetic field
- * Do not put electroconductive materials into this product's vents
- * Please do not disassemble this product without guidance from our professional staff
- * Before booting up this product, confirm that the adapter's input voltage is AC110V-220V and that the output voltage flow meets this product's specification requirements
- * Before plugging in the battery, confirm that the battery's voltage meets this product's specification requirements

About This Manual

This manual provides a detailed introduction to this product's specifications and instructions, operation instructions, reminders, and troubleshooting. Before using this product, please carefully read this manual. If you have any questions or difficulties while using this product, please promptly contact us or our distributor.

Product Introduction

This product is a wireless video transmission kit which operates in 5G band that delivers a video resolution up to 1080P60Hz and is widely applied in field such as live streaming, film and TV production, etc.

Connectivity diagram

This product includes a transmitter and a receiver. The transmitter supports HDMI input or SDI input and output. The receiver supports simultaneous output of 1 HDMI circuit and 2 SDI circuits. The figure below is the connectivity diagram you may refer to.

Point-to-point mode

Support HDMI/SDI signal input and output

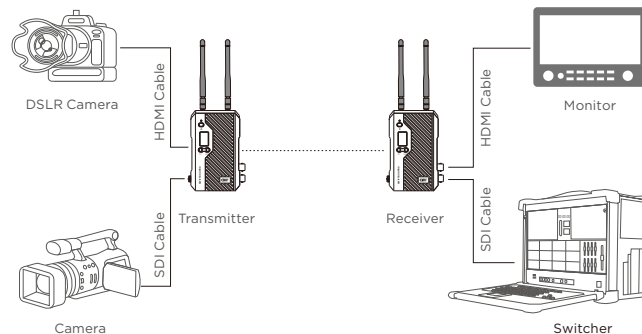

RSTP streaming mode

Support HDMI/SDI signal input and output (Support up to 4 mobile devices)

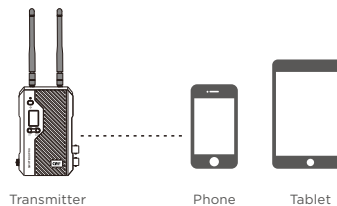

Product Highlights

Deliver quality and low latency video transmission

Support HD-SDI & 3G-SDI input/output and full-HD input/output via HDMI with a resolution up to 1080P60Hz. The built-in H.264 codec delivers smooth video with latency as low as 70ms.

Beamforming

Combine 2x2 MIMO and Beamforming technology that increases wireless beams' directionality and makes them have a higher signal-to-noise ratio, increase the transmission distance, and anti-interference capabilities

Point-to-Point Mode and RTSP Streaming Mode

Support two kinds of working modes: point-to-point and RSTP streaming.

The point-to-point mode supports HDMI/SDI signal input/output.

The RSTP streaming mode supports monitoring via a smart phone or a tablet.

Packing List

The standard parts are listed below.

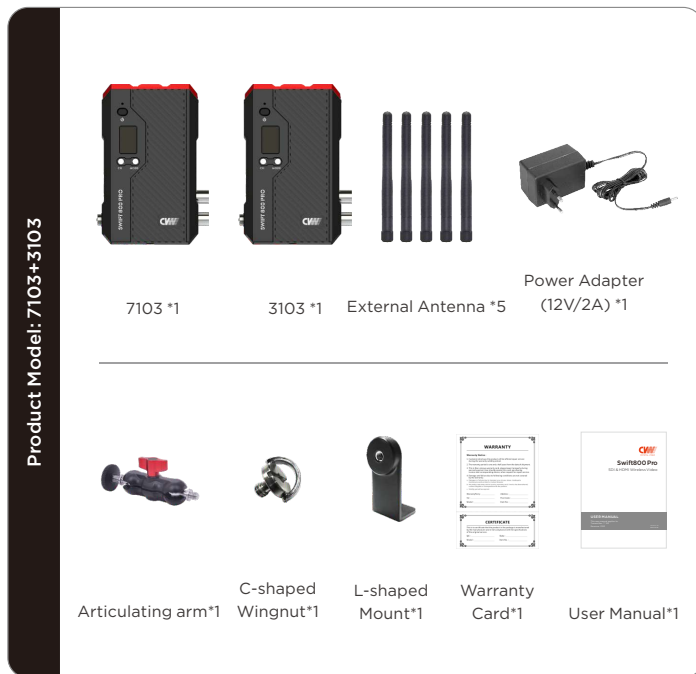

Product Interface Introduction

Transmitter 7103

TX:7103

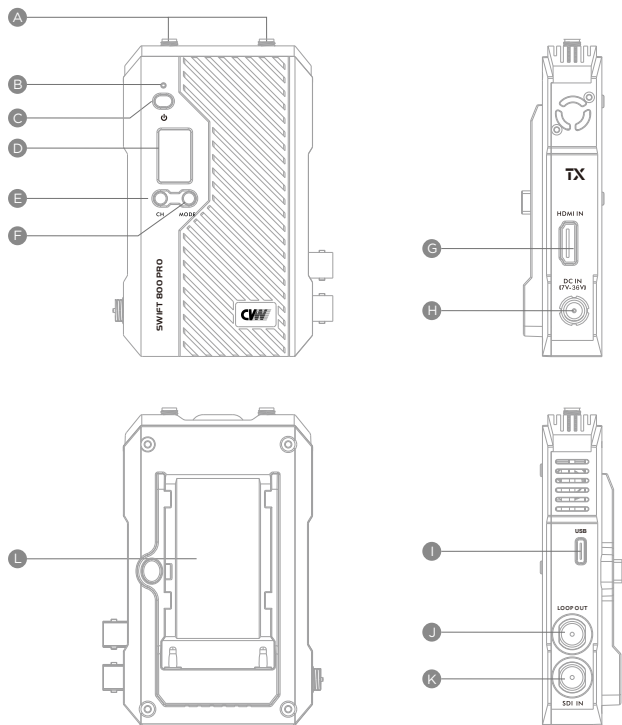

Transmitter 7103 Interface Instructions

Serial Number	Explanation
A	SMA jacks for connectors
B	Low Battery Indicator
C	Power Button
D	OLED Screen
E	CH Button
F	MODE Button
G	HDMI In
H	DC In
I	Type-C USB Port
J	SDI Loop Out
K	SDI In
L	NP-F Battery Slot

Receiver 3103 Interface Instructions:

RX:3103

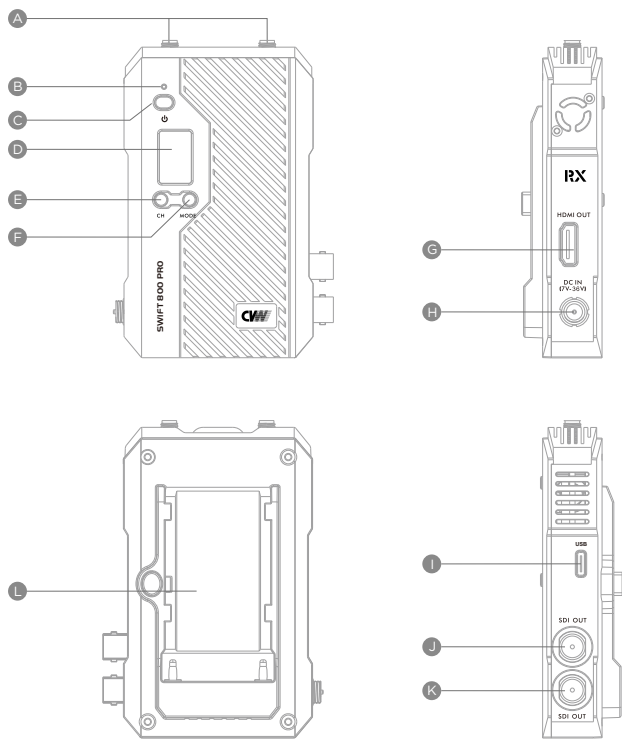

Receiver 3103 Interface Introduction

Serial Number	Explanation
A	SMA jacks for connectors
B	Low Battery Indicator
C	Power Button
D	OLED Screen
E	CH Button
F	MODE Button
G	HDMI Out
H	DC In
I	Type-C USB Port
J	SDI Out
K	SDI Out
L	NP-F Battery Slot

Product Installation Operation Instructions

1. Please install the antennas on the receiver and transmitter via the antenna port.
There should be a 90° angle between each antenna (the optimal installation method) as shown in the picture.

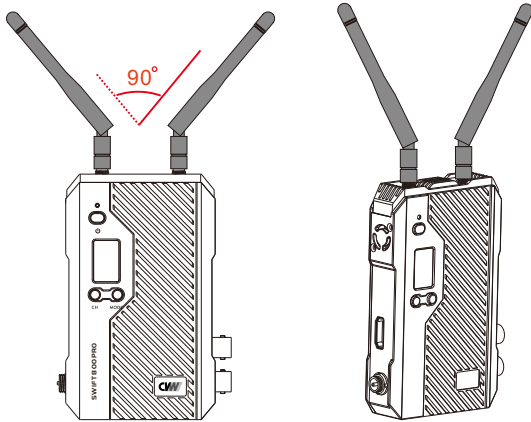

2. Install NP-F batteries in both the transmitter and the receiver

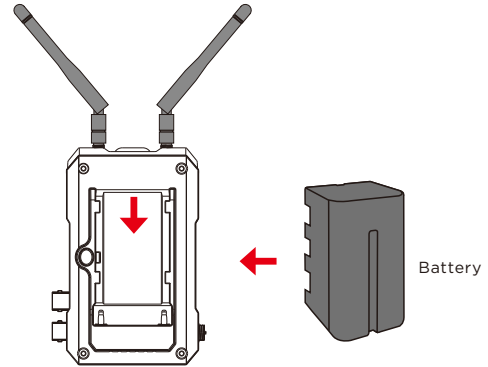

3. Install the transmitter and receiver on the camera using the 1/4 screw hole on the bottom or the L-shaped mount

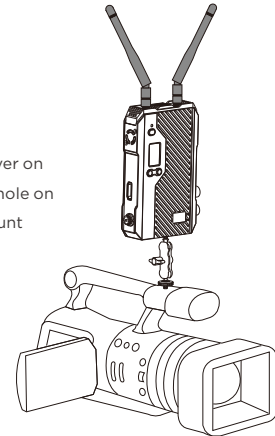

4. Use the HDMI or SDI cable to connect the transmitter to the camera.

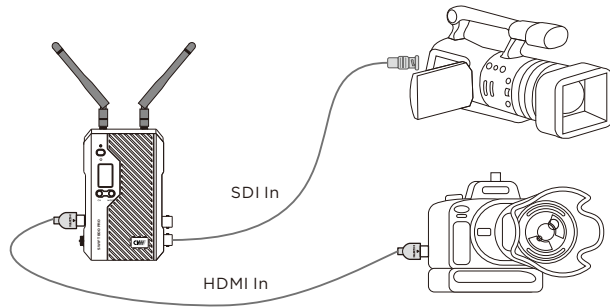

5. Use the HDMI or SDI cable to connect the receiver to the monitor or other receiver end (as shown in the picture).

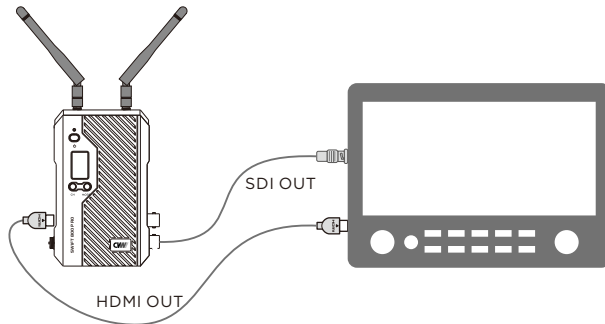

Powering on and booting up

1. Power the transmitter and receiver with three ways as follows

- Install the NP-F battery in the NP-F battery holder on the back of the transmitter.
- Use the attached DC power adapter
- Use a V-mount battery (USB-D to DC power cable is needed in this case).
- Use a power bank (5V/2A) with Type-C cable

2. Booting up the transmitter and receiver requires about 30 seconds. Wireless connection between transmitter and receiver will be established automatically after power up.

OLED Screen

Model: 7103+3013

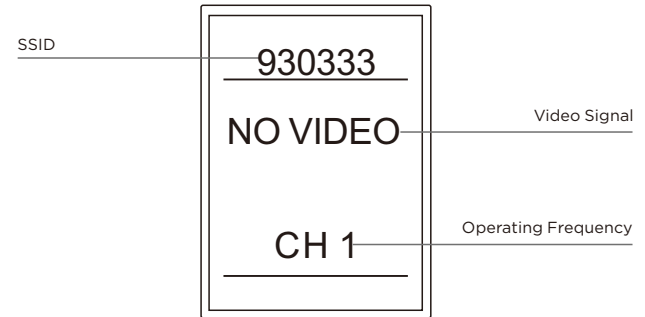
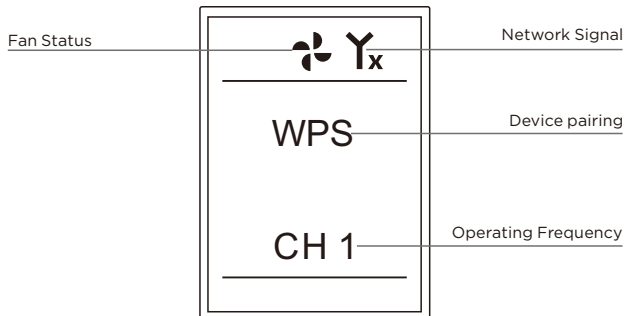
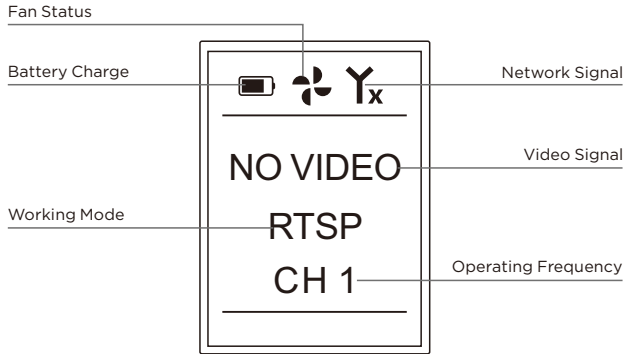

Battery Charge: (Displayed only when using Sony NP-F batteries to supply power)

Fan Status: (When the fan is on, displays rotating fan blades; when the fan is off, displays non-rotating fan blades)

Network Signal: (When the network is not connected, displays 'X'; When the network successfully connects, displays the signal strength)

Video Signal: (When the signal is not recognized, displays 'NOVIDEO'; when the signal is recognized, displays the video format)

Working Mode: (Point-to-point mode: blank display; RTSP mode: displays 'RTSP')

Working Frequency: (Displays the current working frequency)

Product Pairing: (Default does not display; during pairing, it displays 'WPS')

SSID: (Default does not display; touch power button; displays the product's SSID number)

Button Function Instructions

CH Button

Press this button to switch channels.

Long pressing for 3 seconds to enters WPS (WPS requires that both the transmitter and receiver are operating)

Long press 10 seconds to recover to factory settings (restoring the factory settings requires that both the transmitter and receiver are operating)

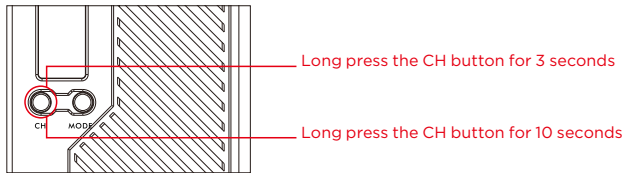

Mode Button

Switch the fan on and off by short pressing the button

Long pressing for 3 seconds can switch between working modes (Point-to-point/RTSP pull streaming)

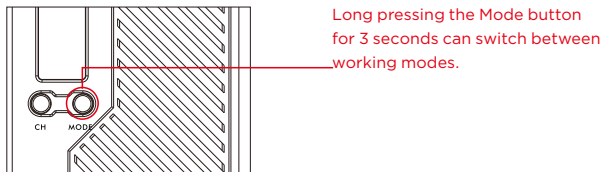

Mode Switching

1. Switching operation must be applied on both the transmitter and receiver.
2. Factory mode is point-to-point mode
3. Long press the transmitter and receiver Mode button for 3 seconds for mode switching, when switching from point-to-point mode to RTSP streaming mode, "RTSP" will be displayed on the OLED display; when switching from RTSP streaming mode to point-to-point mode, "RTSP" will disappear on the OLED display.

Point-to-Point mode:

In point-to-point mode, the video sources can be transmitted via HDMI or SDI port, and the receiver transmits the video to the monitor, switch console, and other devices via HDMI or SDI port.

RTSP streaming mode:

In RTSP streaming mode, transmitter receives the video signal from video source and transmits the video signal to mobile devices (up to four smartphones or iPads)

Power Button

Long pressing for 3 seconds turns this product on and off, and displays 'SSID' by short pressing

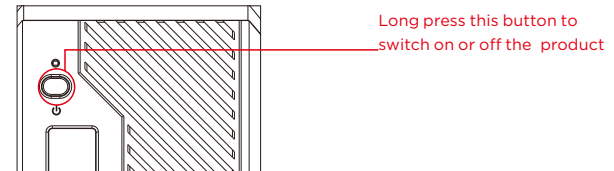

How to Use the App

1. Download the App

App download method can be obtained at www.cv-hd.com

2. Install App

3. Switch the product to RTSP working mode

4. Open the app, click the app's linked icon, and choose the corresponding SSID number. The default SSID uses CVW's format heading (with one touch of the transmitter's power button, the OLED display screen displays the SSID's last six digits). Input password: 12345678 to connect.

5. After successfully connecting, an image displays on the screen, and the menu can be used to choose the corresponding function load.

Product Specifications

Item	TX: 7103	RX: 3103
Frequency	5.10-5.80 (GHz)	
Video Format	1080p60/59.94 , 1080p50, 1080p30/29.97, 1080p25, 1080p24/23.98, 1080psf24/23.98(SDI In) 1080i60/59.94, 1080i50, 720p60/59.94 , 720p50, 480P, 576P, 480i, 576i	
Audio Format	PCM	
HDMI Protocol	HDMI 1.3, HDMI 1.4	
System Latency	70ms	
Transmission range	250m (Line of sight)	
Antenna Mode	2T2R External	
Interfaces	DC-IN, SDI-IN, SDI-LOOP OUT, HDMI-IN, Type-C, USB, Sony NP-F970 Battery Interface SMA Antenna port x 2	DC-IN, SDI-OUT x 2, HDMI-OUT, Type-C, USB, Sony NP-F970 Battery Interface SMA Antenna port x 2
Button	1. POWER; 2. CH; 3. MODE	
Operating voltage	1. DC (7V-36V) 2. Battery Plate: (Sony NP-F Series) 3. Power bank (Type-C 5V2A)	
Product Dimensions	115 x 70 x 21 (Unit: mm, Battery plate not included)	
Operating Temperature	-10~45°C	
Storage Temperature	-40- 80°C	
Product Certification	FCC, CE	
Mechanical interface	1/4 inch nut on the bottom, L-shaped mount	

Reminders

Installing Height and Interval Distance

1. In wide-open and unobstructed conditions, and when using the most optimal installation methods for antennas, this product's transmission distance can reach 250 meters. In obstructed and non-line-of sight conditions, and when using the least optimal installation methods for antennas, this product's transmission distance will decrease.
2. This product's working frequency is 5GHz, its wavelengths are short, and the ground easily absorbs wireless signals. To guarantee transmission stability, it is recommended that the transmitter should be 1.5 meters or more from the ground, and the receiver should be 2 meters or more from the ground.
3. When multiple products are working simultaneously, their working frequency must be staggered and each of them must be 1 or more frequency away from each other. For example, one of them can be set at CH5 and another can be set at CH7, while transmitters must be 2 meters away from each other, and receivers must be 2 meters away from each other.
4. When this product is working at the same time as other wireless devices, to avoid these devices from interfering with each others' signals, please adjust the distance between this product and other wireless devices based on the situation (a recommended distance is 2 meters or more).

Frequency Setting

When using one of these products, it is recommended to set its working frequency to between CH5 and CH9. In environments covered by WiFi and other networks, the spectrum should be at a low occupancy rate, and the frequency will be very stable (Note: When in RSTP mode, it is recommended to set the frequency at CH1 to CH4 or CH10 to CH11, or the phone will be unable to find the SSID).

Cable Connection

- a) First connect the video signal cord, and then turn on the power supply.
- b) During normal usage, avoid hot swapping the video signal cords.

Product and Antenna Installation

- a) This product's antenna cord can be disassembled. Before using it, first install the antenna. After confirming that it is tightly connected, turn on the power supply. If the power supply is turned on first, the antenna may eventually damage this product.
- b) This product is paired with an L-shaped mount and an arm clamp. Firmly install it based on its paired devices.
- c) This product's antenna should be used facing forwards to optimize its transmission effects.

Battery Life

Using a Sony NP-F970 as an example: the NP-F940 battery's capacity is 58WH; the transmitter's power consumption is about 7.5W and the receiver's power consumption is 6W; the NP-F970 battery can be used to power the transmitter for about 5 to 6 hours; the NP-F970 battery can be used to power the receiver for about 7 to 8 hours.

Note: The above values are only for reference use; the battery's energy density, usage environment, and other factors will impact its longevity.

Troubleshooting

1. The transmitter and receiver cannot establish a connection.

- a) Check whether the product's antenna has been installed correctly.
- b) Check whether the power adapter or battery input comply with the product specification requirements.
- c) Check whether the product can boot up normally, and whether the display screen can display normally.
- d) Check whether the product's transmitter and receiver's working mode are matched.
- e) Confirm whether the product's transmitter and receiver have been successfully paired.
- f) The transmitter and receiver should be placed at a distance of about 1 meter; re-pair WPS.

2. The screen is blurry or frozen.

Please confirm whether the following conditions have been met:

- a) Confirm whether the product's working frequency and switching frequency are correct, and prioritize setting them between CH5 and CH9.
- b) Confirm the transmission distance and transmission environment. It is possible to try reducing the distance or increasing the device's height.
- c) Confirm whether multiple products are being used simultaneously. When using multiple products, please separate their working frequencies by 1 or more frequencies. For example, one of them can be set at CH5 and another can be set at CH7, while transmitters must be 2 meters away from each other, and receivers must be 2 meters away from each other.
- d) Confirm whether there are other wireless products in the immediate area. For example, for wireless phone calls, please adjust the distance between this product and other wireless devices based on the situation (a recommended distance is 2 meters or more).

3. The receiver and broadcast station or monitor do not have a screen output.

- a) Check whether the power adapter or battery input comply with this product's specification requirements.
- b) Check whether the product can boot up normally, and whether the display screen can display normally. Check whether the receiver has the startup screen.
- c) Confirm whether the transmitter and receiver can successfully establish a network connection by confirming the signal strength based on the icon on the display screen.
- d) Confirm whether the transmitter's display screen can be used to detect the video format. If the video format is not detected, confirm whether the video source and transmitter are connected normally using a video signal cable.
- e) Confirm whether the receiver's display screen can detect the video format. If the video format is not detected, switch the video source's video format to confirm. For example, in the case of 1080p60 or 1080i50, if the video format is detected, confirm whether the broadcast station and receiver are connected normally using a video signal cable.

4. Output image has a green splash screen.

- a) Confirm whether the transmitter or receiver's video signal cable has a good connection.
- b) Use SDI/HDMI as the digital signal and a fast transmission rate, and is it recommended to use brand-name cables.

Note: If the above problems cannot be resolved by using these quick solutions, please contact the distributor or factory for technical support.